

< Accommodation Ladder >

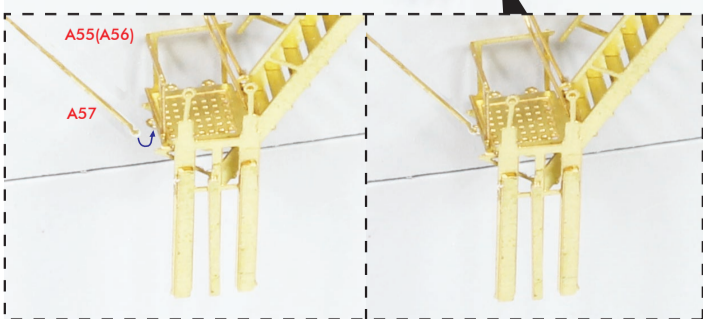

< Rigged Stern Boat Boom >

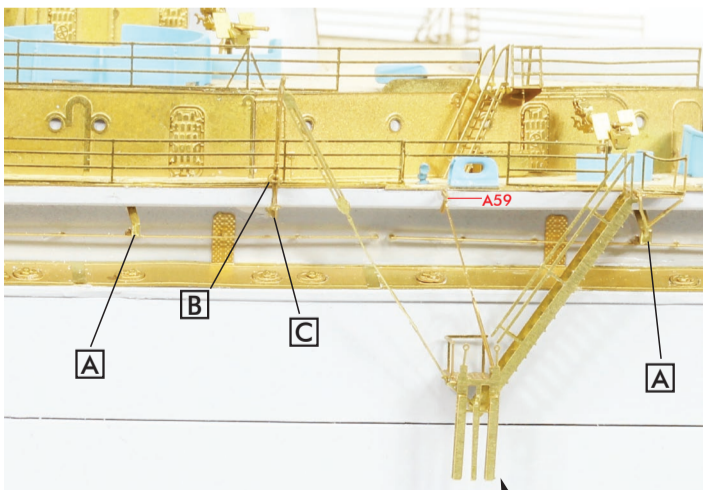
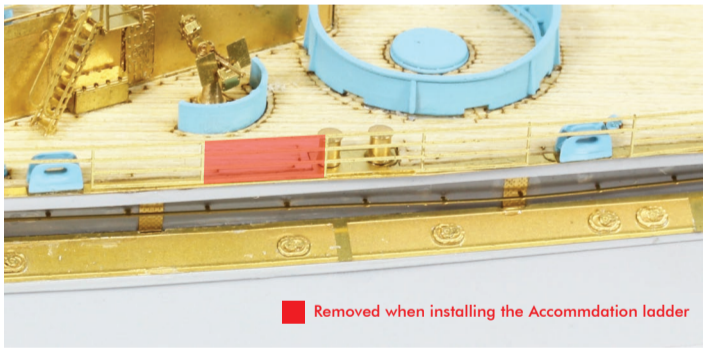
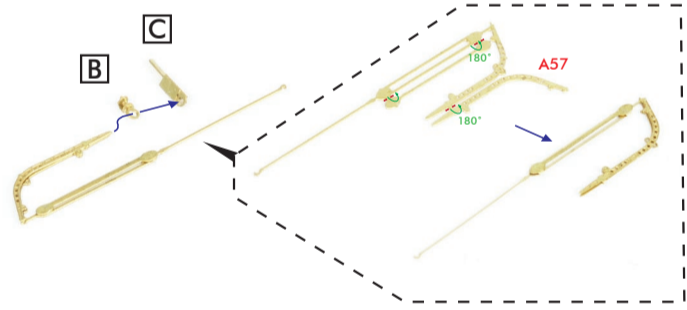
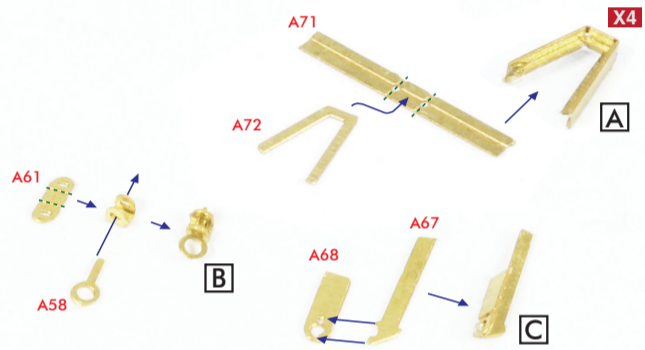
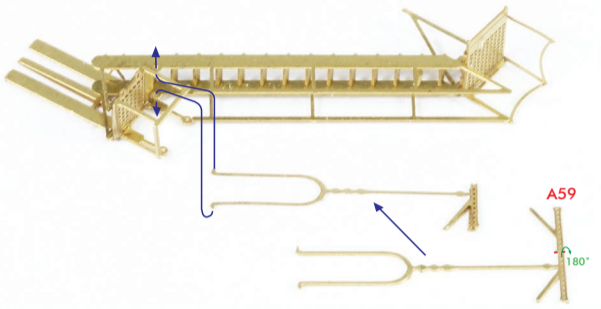
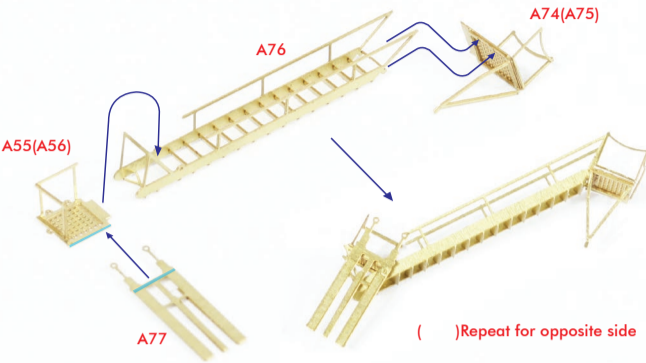
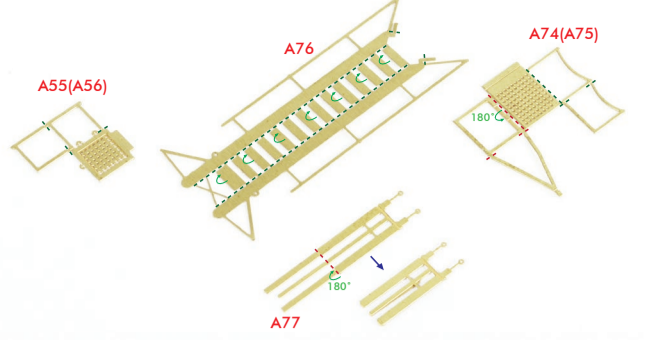
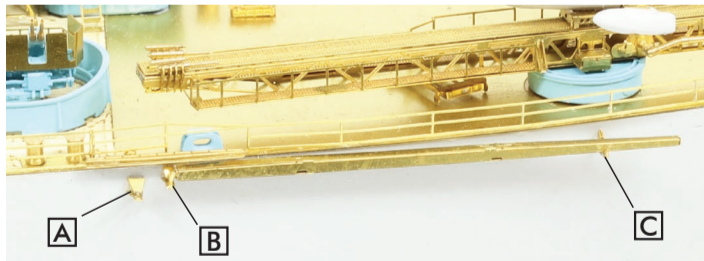
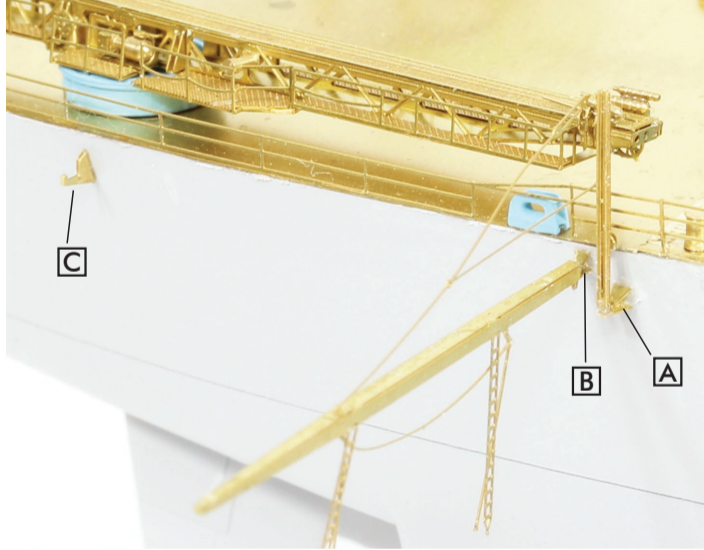
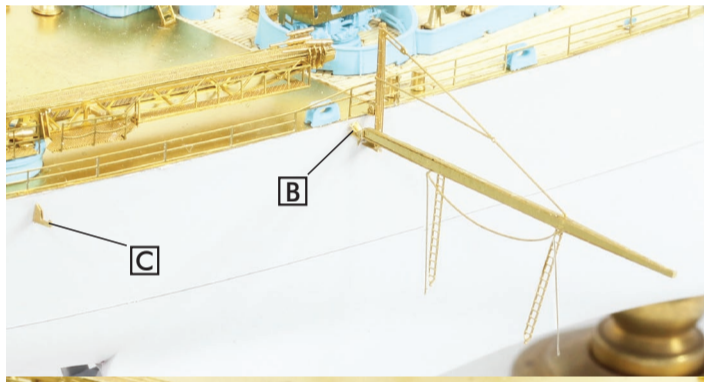
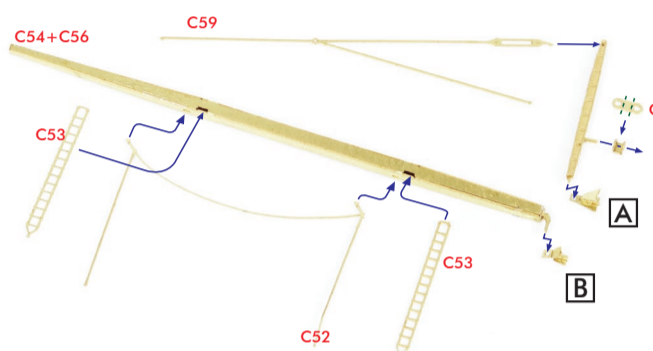
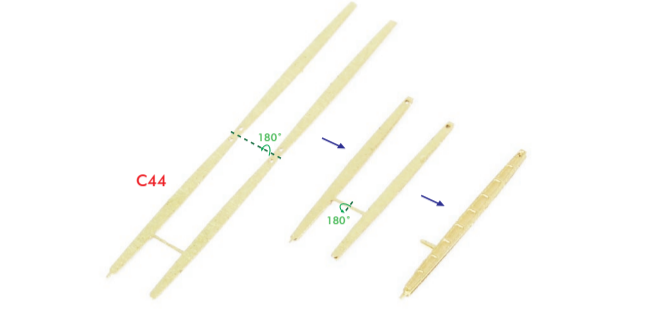
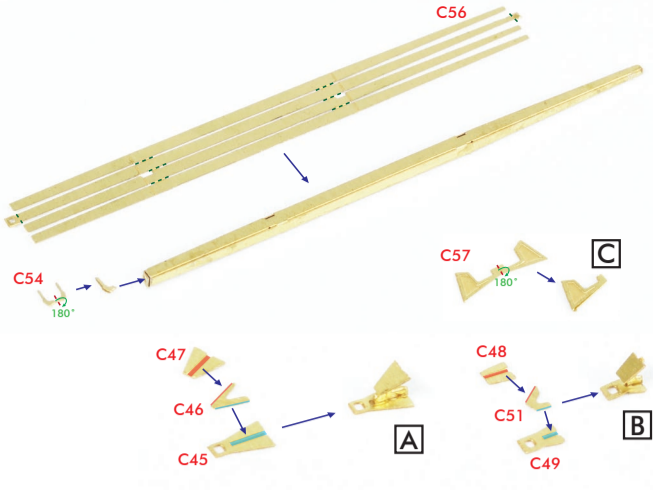

< Aircraft Deck Cradle >

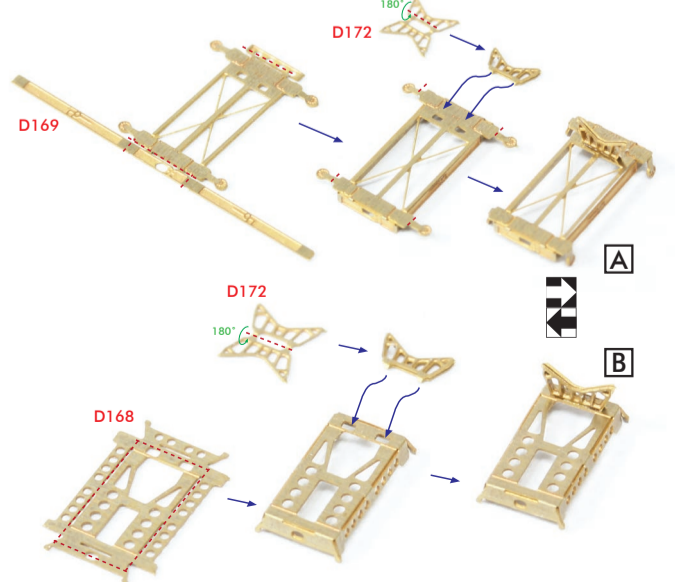

< 26FT Motor Whaleboat >

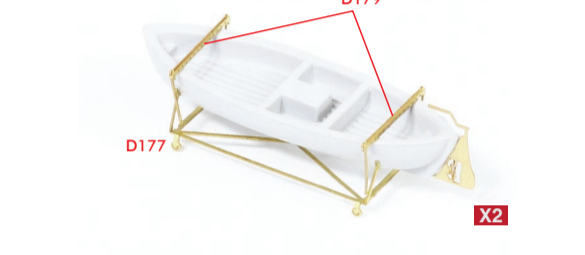

< Vought OS2U-1 Kingfisher >

